

# TECHNICAL DRAWING

## YXJ-11020

70CL—650gr / Extra Flint Material

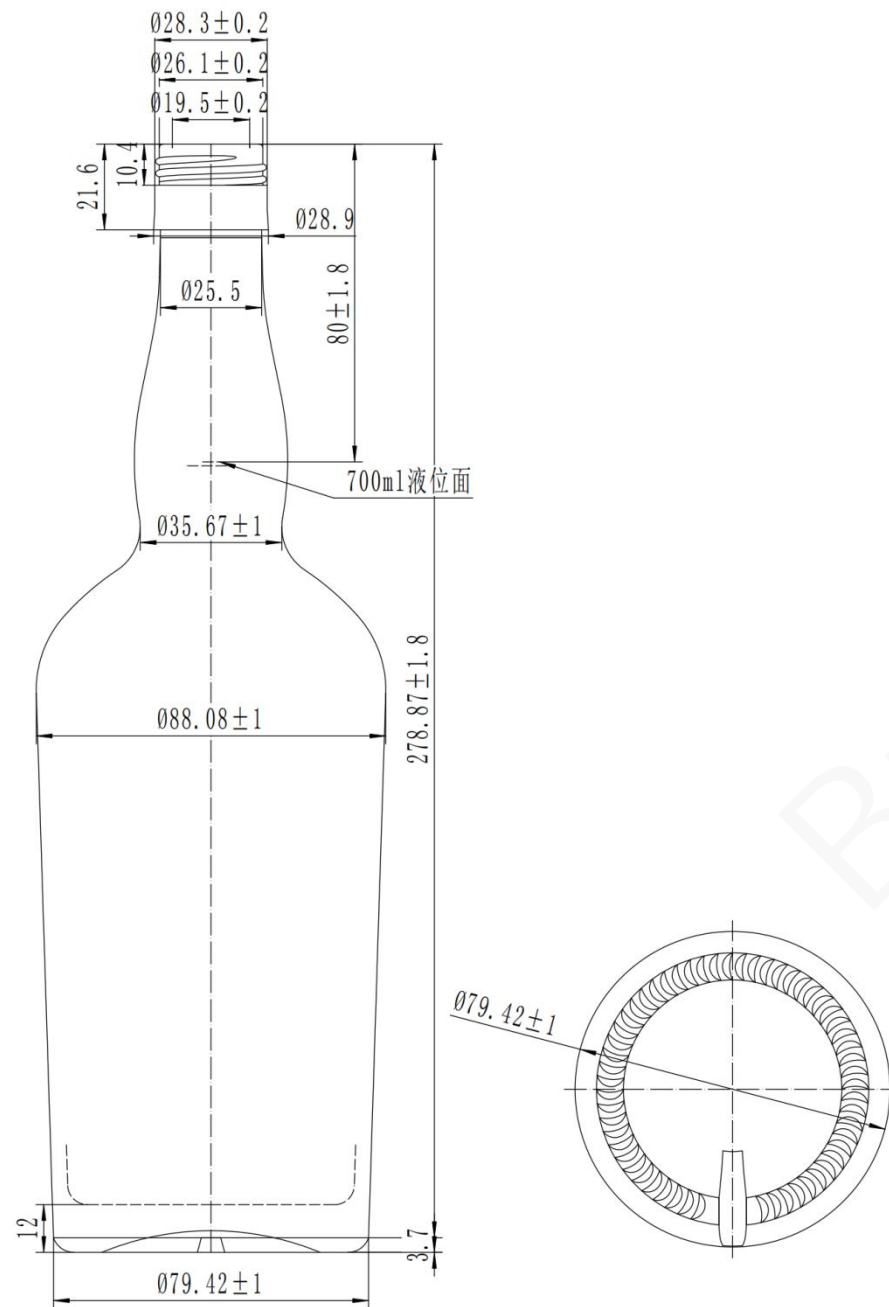

**BRIVERGLASS**

NAME OF BOTTLE :		YXJ-11020 70CL	
CAPACITY :	700ml	GLASS WEIGHT :	650g
FULL CAPACITY :	725ml	GLASS HEIGHT :	278.8±1.8mm
DIAMETER :	88.08±1mm	MATERIAL :	EXTRA FLINT
FINISH OUTSIDE :	28.3±0.2mm	FINISH INSIDE :	19.5±0.2mm

Please carefully review the technical drawings. Bottles that comply with the technical drawings are considered qualified products.

Info@briverglass.com | www.briverglass.com